

Product Parts Breakdown

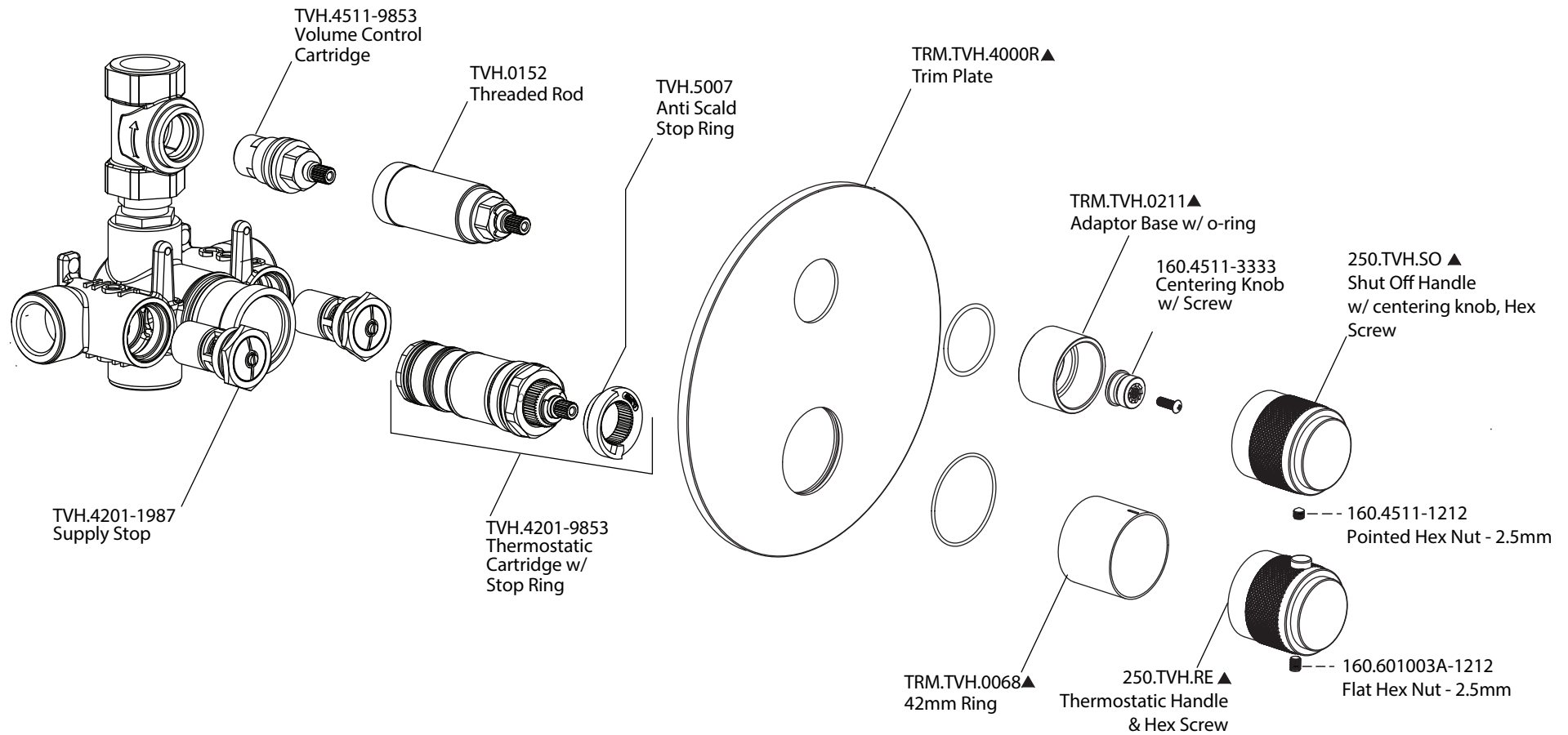

isenberg
innovation+design

250.4101